

**NOTE:**  
All Filters are tested and checked for leaks prior to shipping. Some residual water may be inside your Filter – This is Normal.

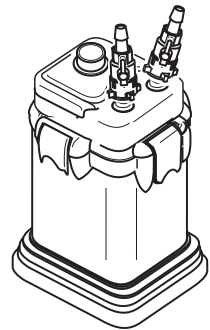

### CANISTER FILTER PARTS LIST

#	DESCRIPTION	QTY	PART #
A	Hose	2	CCF101
B	Spray Bar (4 pieces)	1	CCF102
C	Intake/Exhaust Tube	1	CCF103
D	Elbow Tube	1	CCF105
E	Suction Cups	8	CCF107
F	Strainer	1	CCF108
G	Directional Spout	1	CCF109
H	Flow Control Valves	2	CCF110
I	Motor Unit 500 for 110 volt for 220 volt for 220 volt - UK Plug	1	CCF112 CCF112F CCF112UK
J	Media Basket Cover	1	CCF122
K	Media Basket Joint*	2	CCF220
L	Media Basket O-Ring*	2	CCF221
M	Media Basket	2	CCF123
N	Media Basket Clips	2	CCF126
O	Coarse Sponge	1	CCF129
P	Floss Pad	2	CCF131
Q	Carbon Bag	1	CCF233
R	Lock Clips	2	CCF125
S	Filter Case	1	CCF124

### IMPORTANT NOTE:

Parts T-Y are already installed inside of the motor of your new canister filter. You will not find them separately in the box.

#	DESCRIPTION	QTY	PART #
T	Impeller for Cascade 500 for 110 volt for 220 volt	1	CCF115 CCF115F
U	Impeller Retainer	1	CCF119
V	Impeller Retainer O-Ring	1	CCF118
W	Motor Gasket	1	CCF117
X	Exhaust Tube O-Ring	1	CCF127
Y	Intake/Extension Tube O-Ring	1	CCF128

\*A spare media basket O-Ring is included with your filter. Keep this spare part in a safe place in case your media basket O-Ring needs to be serviced in the future.

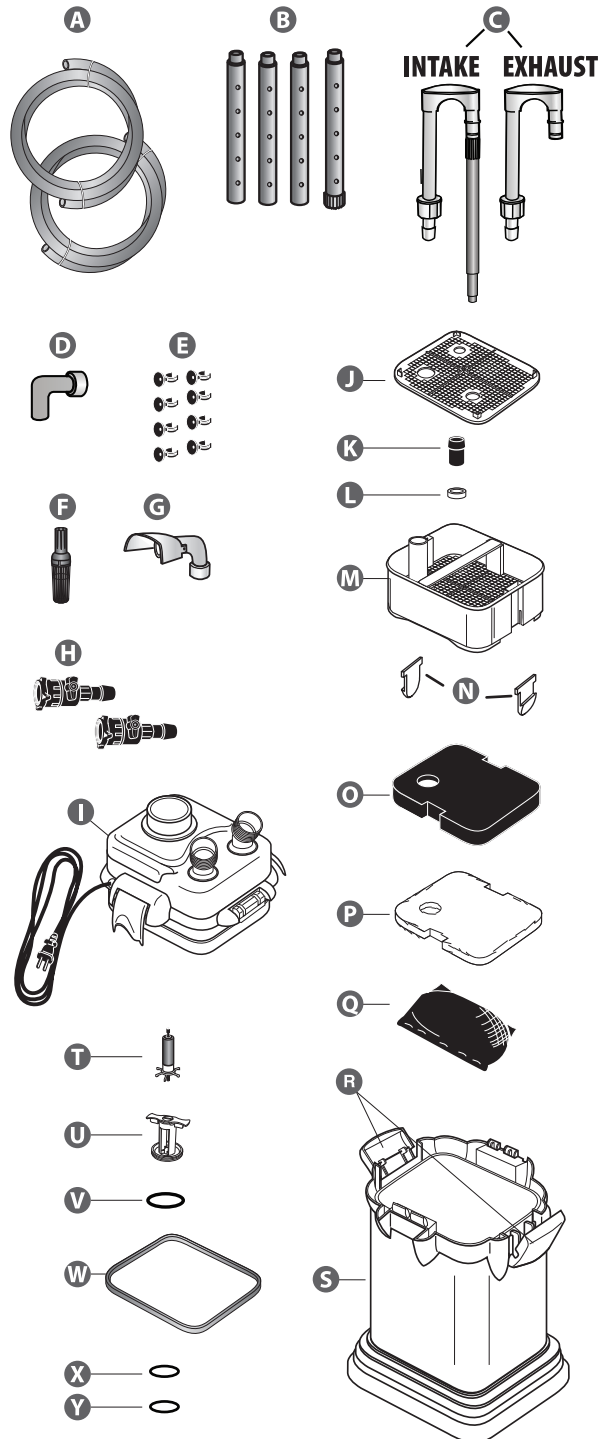

### 1 Prepare Filter

Open lock clips. Remove motor unit.

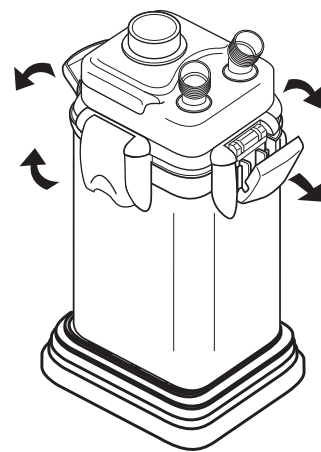

### 2 Remove filter baskets from filter case.

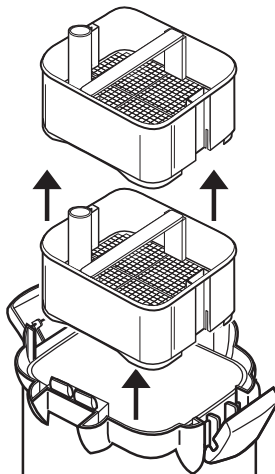

3 Place coarse sponge in bottom basket. Place carbon and floss pads in upper basket. Your filter includes quality Cascade brand filter media, but you may choose to use the filter media of your choice. Baskets click together to lock into place when properly aligned. Do not overfill media baskets.

**NOTE** Your biological media (coarse sponge) must be in the bottom-most basket of your filter. You can arrange the other media in any configuration you wish.

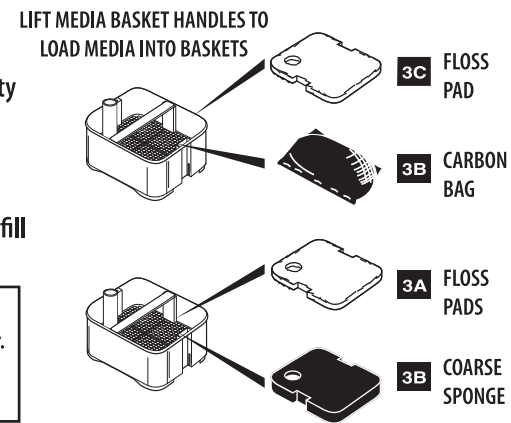

Rinse carbon bag and media baskets to remove any carbon dust prior to setting up filter

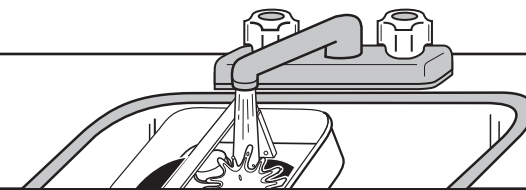

4 Place media basket joint, media basket O-ring and media basket cover over TOP BASKET

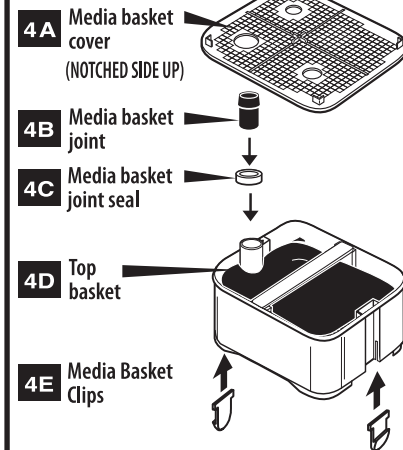

### 5 Reassemble Filter

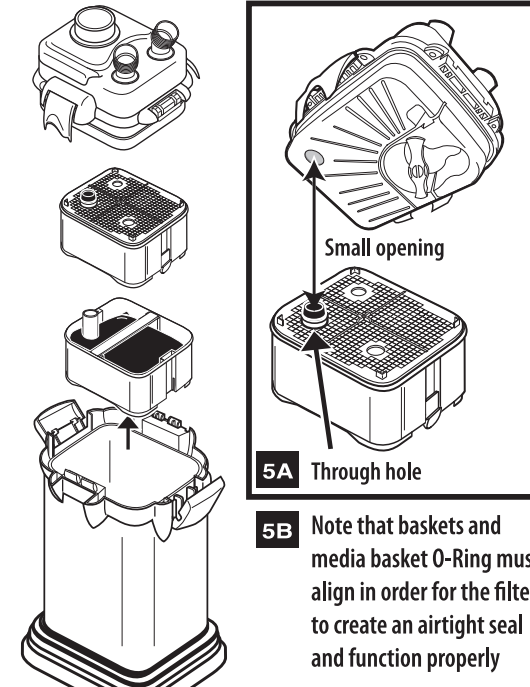

### 6 Valves

Attach valves to ports on motor unit. Attach valve with BLUE ring to blue "IN" port. Attach valve with black ring to BLACK "OUT" port.

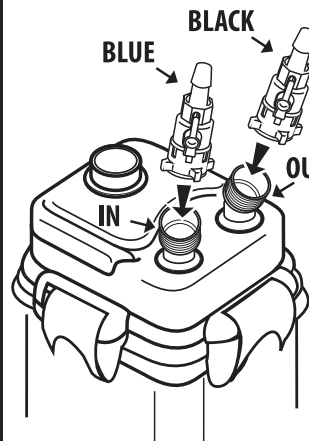

### 7 Position Filter

7A Your Cascade filter uses gravity to properly filter your aquarium. Be sure to place your filter in a location where it will be lower than the water level of your aquarium, as shown below.

7B Note that hoses with valves will easily detach from motor to remain at aquarium during filter maintenance.

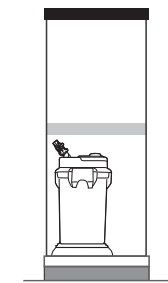

### 8 Hose Attachment

Attach hose to intake tube as shown below.

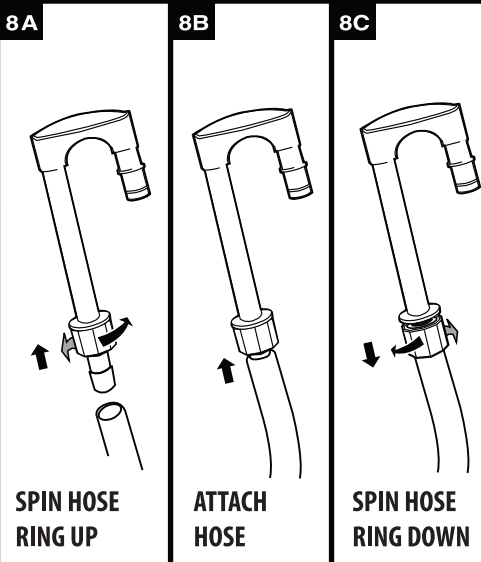

Attach strainer to intake tube.

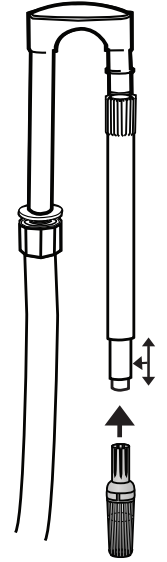

8E Use two suction cups to secure intake tube to aquarium wall.

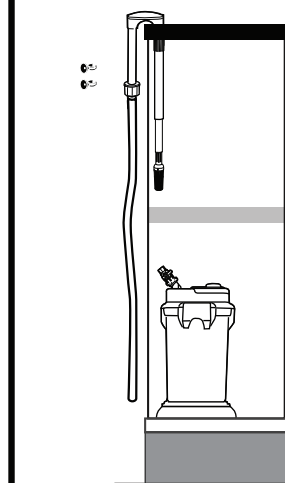

8F **NOTE** Intake tube length is adjustable

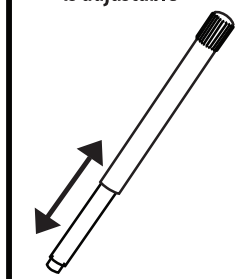

### 9 Exhaust Hose Assembly

YOU HAVE 2 OPTIONS:

#### 9A Spray Bar

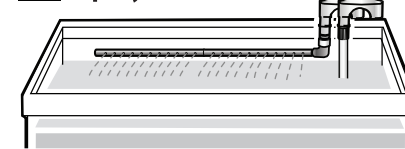

- Evenly distributes filtered water across length of the aquarium.
- Breaks surface water to provide oxygen exchange.

#### 9B Spray Bar Assembly

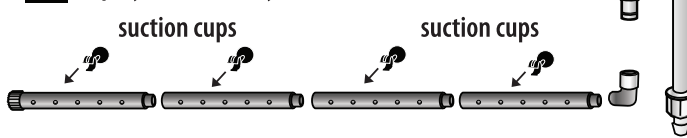

#### 9C Directional Spout

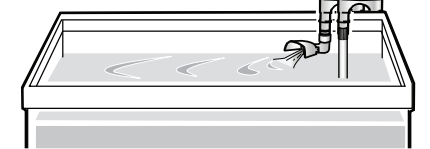

- Creates a forceful circulating flow in any direction.
- Breaks surface water to provide oxygen exchange.

#### 9D Directional Spout Assembly

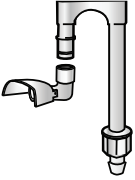

- 10** Attach exhaust tube assembly to remaining hose (see step 8 for hose attachment).

Secure to aquarium using suction cups as needed.

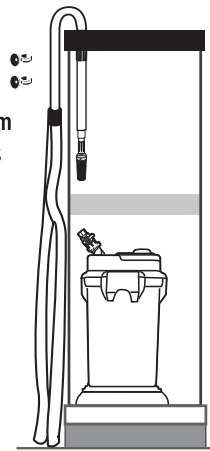

**11 Trim Hoses**

Carefully estimate the correct hose length to avoid unnecessary bends.

Trim hoses with scissors.

HOSES TOO LONG      CORRECT LENGTH

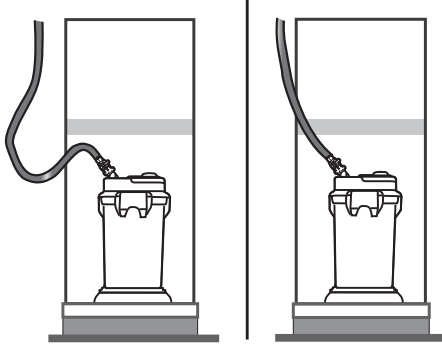

**12 Attach Hoses**

**12A** Important

**12B** Attach intake hose to valve with blue ring and exhaust hose to valve with black ring.

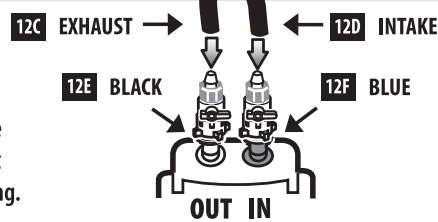

HOSE

**12G** SPIN HOSE RING DOWN

**12H** PRESS HOSE DOWN

**12I** SPIN HOSE RING UP

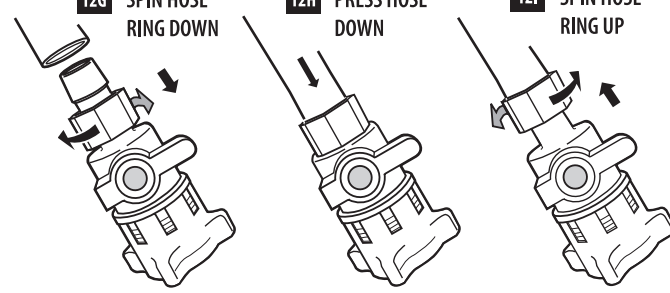

**13** Turn both flow control levers to full open position.

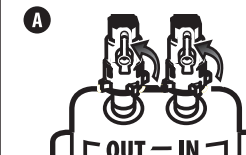

**B** Pump repeatedly until water starts to flow into filter.

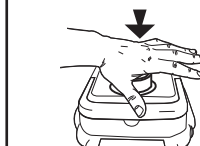

**C** Wait 1 minute for filter canister to fill.



**D** Connect power.

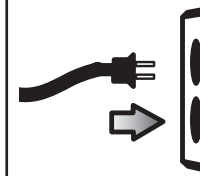

OR

**A** Disconnect the hoses from the motor unit.

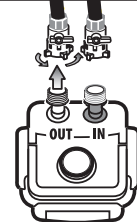

**B** Remove the motor from the canister.

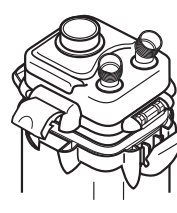

**C** Fill the canister 3/4 of the way with water from your aquarium. Wait 1 minute for filter canister to fill.



**D** Reattach the motor.

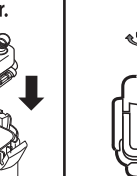

**E** Reattach hoses.

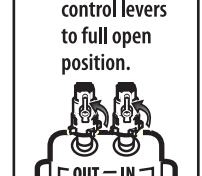

**F** Turn both flow control levers to full open position.



**G** Pump repeatedly until water starts to flow into filter.

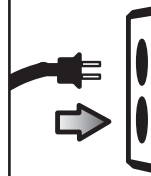

**H** Connect power.

Please note that your filter motor may generate noise for the first 15-30 seconds of operation. This is normal. If the motor continues to make noise beyond the first 15-30 seconds, there is not enough water in the filter canister. Repeat the steps from diagram 13 and plug your filter back in. You may also notice occasional noise coming from your filter for the first few days of operation. That noise is caused when air pockets that are trapped in your filter are released through the output hoses. To eliminate air pockets inside your filter, gently fill the entire filter from side to side and rock the filter back and forth. Be careful not to put any additional stress on the hoses or connections to the filter.

**MAINTENANCE:** Periodically change the filter media, clean hoses and impeller. Your tank conditions will determine how often this should be done.

**A IMPORTANT!**

- You can leave the hoses at the aquarium when servicing filter
- DISCONNECT IN THE FOLLOWING SEQUENCE**

- Close flow control lever on BLUE intake valve. Do not close lever on BLACK exhaust valve.
- With power ON, unscrew Lock Ring on BLUE Intake Valve and Disconnect.
- Close flow control lever on BLACK Exhaust Valve.
- Disconnect power cord.
- Unscrew Lock Ring and disconnect BLACK Exhaust Valve.

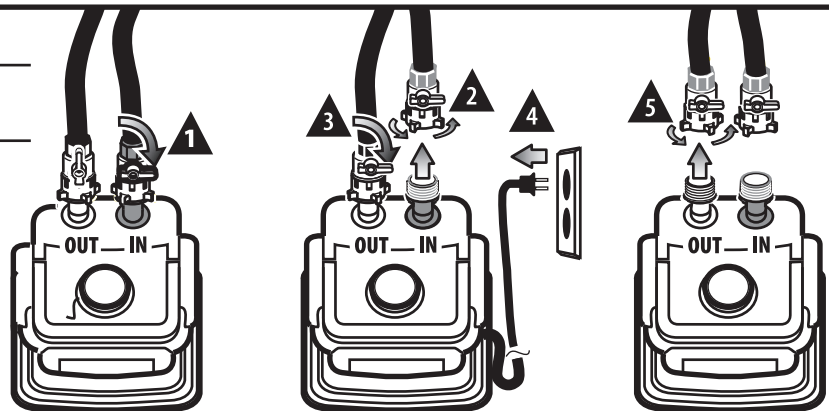

**B Open Filter • Bring Filter To Sink**

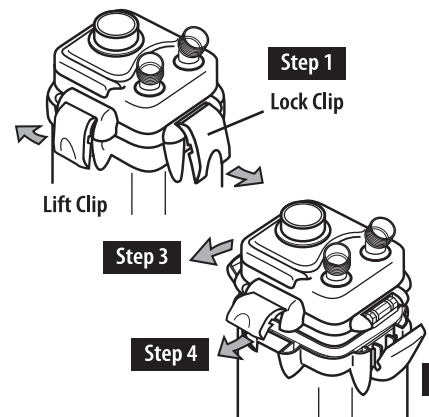

- Open by pulling out on lock clips (2 sides)
- Lift lock clips upward.
- Pivot top end of lock clips outward.
- Pivot both lift clips (2 sides) to break suction and lift motor unit away from filter canister.

**IMPORTANT SAFETY INSTRUCTIONS**

**WARNING** – To guard against injury, basic safety precautions should be observed, including the following:

- READ AND FOLLOW ALL SAFETY INSTRUCTIONS.**
- DANGER** - To avoid possible electric shock, special care should be taken since water is employed in the use of aquarium equipment. For each of the following situations, do not attempt repairs by yourself; return the appliance to an authorized service facility for service or discard the appliance:
  - If the appliance falls into the water, **don't reach for it!** First unplug it and then retrieve it. If electrical components of the appliance get wet, unplug the appliance immediately. (Non-immersible equipment only).
  - If the appliance shows any sign of abnormal water leakage, immediately unplug it from the power source (Immersible equipment only).
  - Carefully examine the appliance after installation. It should not be plugged in if there is water on parts not intended to be wet.
  - Do not operate any appliance if it has a damaged cord or plug, or if it is malfunctioning or has been dropped or damaged in any manner.
  - To avoid the possibility of the appliance plug or receptacle getting wet, position aquarium stand and tank to one side of a wall-mounted receptacle to prevent water from dripping onto the receptacle or plug. A "drip loop," shown in the figure below, should be arranged by the user for each cord connecting an aquarium appliance to a receptacle. The "drip loop" is that part of the cord below the level of the receptacle, or the connector if an extension cord is used to prevent water traveling along the cord and coming in contact with the receptacle. If the plug or receptacle does get wet, DON'T unplug the cord. Disconnect the fuse or circuit breaker that supplies power to the appliance. Then, unplug and examine for presence of water in the receptacle.

**C Replace**

Replace expendable media such as carbon, zeolite, and filter resins. Rinse or replace floss pads and coarse sponge. Note that coarse sponge may contain valuable colonies of helpful bacteria that you may wish to maintain. Gently rinse and squeeze the coarse sponge in some aquarium water that you took from the aquarium. This will reduce clogging, but not kill off the entire bacterial colony. Tap water, with chlorine, should not be used on the coarse sponge filter since it may kill bacteria.

**D Reload**

When reloading media baskets into canister, make certain that through holes align with each other and with the small opening on the motor unit. See steps 4 and 5 on page 1.

**E Impeller Maintenance**

**E1** Turn motor unit upside down. Twist impeller retainer counter clockwise and pull upwards. Remove entire impeller with rubber caps and shaft.

**E2** Rinse impeller in running water. A soft brush can be used to remove any build up. Do not use soap or detergent.

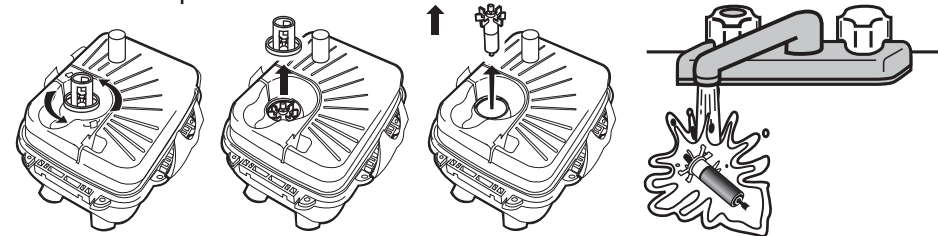

**F Hoses**

Periodically remove hoses and tubes from aquarium. Clean with filter brush and flush thoroughly.

**G Note**

For re-assembly keep both valve levers closed until both valves are completely connected to the motor. Then open as described in step 13.

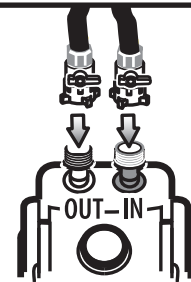

Please visit [www.fixyourfilter.com](http://www.fixyourfilter.com) for questions / tips / directions for troubleshooting your filter

**1 YEAR WARRANTY**

Read these terms carefully. Retain this sheet with your sales slip. Please DO NOT return this product to your dealer. If service or replacement is necessary, please visit [www.penn-plax.com/customerservice](http://www.penn-plax.com/customerservice), email us at [cs@pennplax.com](mailto:cs@pennplax.com), or call 631-273-2059 (US & Canada Only) for further instructions on how to obtain warranty repair.

- This product is warranted under normal usage against defective material and workmanship for a period of 1 year from date of purchase. Repairs and replacements will be made at our discretion, free of any charge for parts and or labor.
- This warranty will not apply to any product which has been subject to misuse or negligence.
- Penn-Plax® assumes no liability with respect to loss or damage to livestock or personal property, irrespective of the cause thereof. The warranty is in lieu of all warranties, expressed or implied, including the implied warranty of merchantability. Neither the seller nor manufacturer shall be liable for any loss or damage, consequential or direct, arising from the use or inability to use this product. Defects resulting from misuse, abuse or accident are expressly excluded from coverage under this warranty. Some states do not allow imitation on how long an implied warranty lasts or do not allow any exclusion or limitation of incidental or consequential damages, so the limitations may not apply to you.

**WARRANTY S&H COSTS**

- Complete Filter Replacement – \$40
- Replacement Motor – \$20
- All Other Replacement Parts: – \$15



© 2022 PENN-PLAX, INC., 35 MARCUS BLVD. HAUPPAUGE, NY 11788 USA  
CCF1UL-Cascade-500-INSTRUCTIONS-English-BACK-2022-FINAL.ai 2204

**SAVE THESE INSTRUCTIONS**

- Close supervision is necessary when any appliance is used by or near children.
- To avoid injury, do not contact moving parts or hot parts such as heaters, reflectors, lamp bulbs, and the like.
- Always unplug an appliance from an outlet when not in use, before putting on or taking off parts, and before cleaning. Never yank cord to pull plug from outlet. Grasp the plug and pull to disconnect.
- Do not use an appliance for other than the intended use. The use of attachments not recommended or sold by the appliance manufacturer may cause an unsafe condition.
- Do not install or store the appliance where it will be exposed to the weather or to temperatures below freezing.
- Make sure an appliance mounted on a tank is securely installed before operating it.
- Read and observe all the important notices on the appliance.
- If an extension cord is necessary, a cord with proper rating should be used. A cord rated for less amperes or watts than the appliance rating may overheat. Care should be taken to arrange the cord so that it will not be tripped over or pulled.

